

INFRARED RADIOMETERS

SI-100 Series, SIF-100 Series, SI-400 Series, SIL-100 Series, & SIL-400 Series

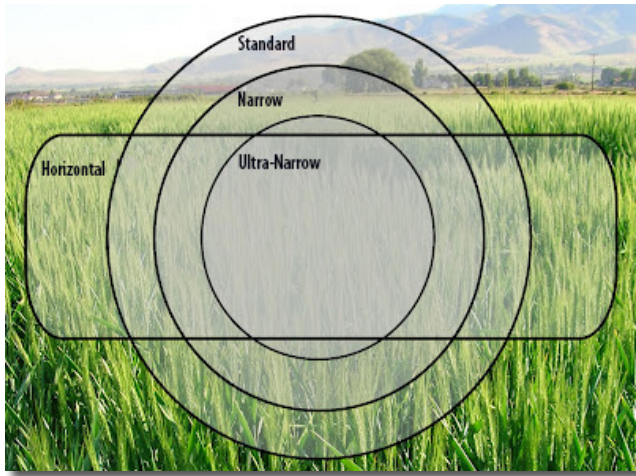

Spectral Response

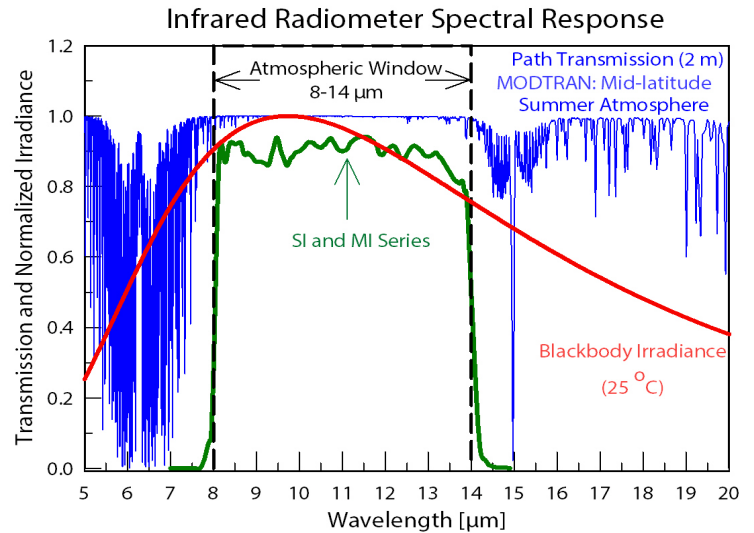

Above: Spectral response of SI series infrared radiometers. Spectral response (green line) is determined by the germanium filter and corresponds closely to the atmospheric window of 8 to 14 μm , minimizing interference from atmospheric absorption/emission bands (blue line) below 8 μm and above 14 μm . Typical terrestrial surfaces have temperatures that yield maximum radiation emission within the atmospheric window, as shown by the blackbody curve for a radiator at 25 C (red line).

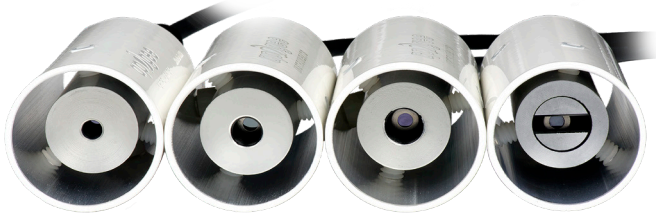

Ultra Narrow 14° half-angle	Narrow 18° half-angle	Standard 22° half-angle	Horizontal 13° x 32° half-angles
--------------------------------	--------------------------	----------------------------	-------------------------------------

High-Accuracy Measurements

All Apogee IR sensors are NIST traceable and include a calibration certificate. Sensors are calibrated to a custom black-body cone, with the **Research-Grade sensors** featuring a measurement uncertainty of ± 0.2 C from -30 to 65 C when the sensor (detector) temperature is within 20 C of the surface (target) being measured. Lower-cost **Commercial-Grade sensors** have a measurement uncertainty of ± 0.5 C from 0 to 50 C when the sensor is within 20 C of the surface target. Radiometers are only sensitive from 8 to 14 μm (atmospheric window) to minimize the influence of water vapor and CO₂ on the measurement.

Features

TYPICAL APPLICATIONS

- Plant water status estimation
- Road surface temperature measurement for determination of icing conditions
- Terrestrial surface (soil, vegetation, water, snow) temperature measurement in energy balance studies

OUTPUT OPTIONS

Research-Grade sensors are available in analog and digital outputs including unamplified voltage outputs, SDI-12, and Modbus communication protocols. Research-Grade sensors are also available attached to a hand-held meter with digital readout. **Commercial-Grade models** come in an analog (SIL-111) and SDI-12 (SIL-411) output.

RUGGED HOUSING

Anodized aluminum body with fully-potted electronics. **Research-Grade** radiation shields are made from powder-coated aluminum with a polished interior for lower emissivity. **Commercial-Grade** radiation shields are made from rugged, polished, UV-resistant ASA plastic.



Commercial-Grade (SIL-111/411)
22° half-angle

Research- vs Commercial-Grade

	Research-Grade	Commercial-Grade
Accuracy	± 0.2 C from -30 to 65 C	± 0.5 C from 0 to 50 C
Shield Material	Powder-coated aluminum with a polished interior	Rugged, polished, UV-resistant ASA plastic
Field of View	Three circular and two horizontal apertures	Single 22° half-angle
Cost	More accurate for higher cost	Less accurate for lower cost
Cable Connector	IP68 stainless-steel cable connector to simplify sensor removal	No connector



Output Options

- Analog Response
- Fast response (SIF) with 0.2 second response time
- Hand-held meter

Product Specifications

	SI-111-SS	SIL-111	SI-121-SS	SI-131-SS	SI-1H1-SS	SIF-111-SS	SIF-121-SS	SIF-1H1-SS
Analog Model Output (Difference between Target and Detector)	≈ 50 μV per C		≈ 30 μV per C	≈ 15 μV per C	≈ 30 μV per C	≈ 15 μV per C	≈ 10 μV per C	
Input Voltage Requirement	2500 mV thermistor excitation (typical, other voltages can be used)							
Analog Output from Thermistor	0 to 2500 mV (typical, depends on input voltage)							
Calibration Uncertainty (0 to 50 C), when target and detector ΔT are < 20 C	0.2 C	0.5 C	0.2 C	0.3 C	0.2 C	—		
Calibration Uncertainty (-30 to 65 C), when target and detector ΔT are < 20 C	0.2 C	—	0.2 C	0.3 C	0.2 C			
Calibration Uncertainty (-40 to 80 C), when target and detector ΔT are > 20 C	0.5 C	—	0.5 C	0.6 C	0.5 C			
Measurement Repeatability	Less than 0.05 C							
Long-term Drift	Less than 2 % change in slope per year when germanium filter is maintained in clean condition							
Response Time	0.6 s, time for detector signal to reach 95 % following a step change					0.2 s, time for detector signal to reach 95 % following a step change		
Field of View (half-angle)	22°		18°	14°	32° horizontal; 13° vertical	22°	18°	32° horizontal; 13° vertical
Spectral Range	8 to 14 μm; atmospheric window							
Operating Environment	-50 to 80 C; 0 to 100 % relative humidity (non-condensing)							
Dimensions	23 mm diameter, 60 mm length							
Cable	5 m of four conductor, shielded, twisted-pair wire; TPR jacket (high water resistance, high UV stability, flexibility in cold conditions); pigtail lead wires; stainless steel (316), M8 connector located 25 cm from sensor head							
Mass (5 m of cable)	190 g							
Warranty	4 years against defects in materials and workmanship							

Road Weather Networks

The SI-4HR-SS (SDI-12) and SI-5HR-SS (Modbus) infrared radiometers are developed for road weather networks specifically, with a 10° vertical field of view, allowing for remote detection of a narrow and distant target roadway. The rectangular-shaped aperture maximizes the horizontal field of view allowing for a larger integrated measurement without including undesired target areas such as sky or surrounding terrain. The elongated external shield is designed to better protect from snow and ice building up on the sensor.

SI-4HR-SS

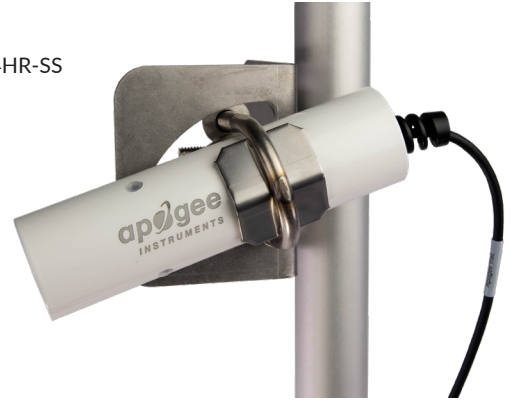

Output Options

- SDI-12
- Modbus



Product Specifications

All Models -SS	SI-411	SI-421	SI-431	SI-4H1	SI-4HR	SIL-411	SI-511	SI-521	SI-531	SI-5H1	SI-5HR
Input Voltage Requirement	5.5 to 24 V DC										
Current Draw	1.5 mA (quiescent), 2.0 mA (active)					RS-232 quiescent 37 mA, active 37 mA; RS-485 quiescent 37, active 42 mA			RS-232 29 mA; RS-485 30 mA		
Calibration Uncertainty (0 to 50 C), when target and detector ΔT are < 20 C	0.2 C	0.3 C	0.2 C	0.3 C	0.5 C	—					
Calibration Uncertainty (-30 to 65 C), when target and detector ΔT are < 20 C	0.2 C	0.3 C	0.2 C	0.3 C	—	0.2 C	0.3 C	0.2 C	0.5 C		
Calibration Uncertainty (-40 to 80 C), when target and detector ΔT are > 20 C	0.5 C	0.6 C	0.5 C		—	0.5 C	0.6 C	0.5 C	1 C		
Measurement Repeatability	Less than 0.05 C										
Long-term Drift	Less than 2 % change in slope per year when germanium filter is maintained in a clean condition										
Response Time	0.6 s, time for detector signal to reach 95 % following a step change					—					
Field of View (half-angle)	22°	18°	14°	32° horizontal; 13° vertical	16° horizontal; 5° vertical	22°	18°	14°	32° horizontal; 13° vertical	16° horizontal; 5° vertical	
Spectral Range	8 to 14 μm; atmospheric window										
Operating Environment	-50 to 80 C; 0 to 100 % relative humidity (non-condensing)										
Dimensions	23 mm diameter, 60 mm length				23 mm diameter, 76 mm length	23 mm diameter, 60 mm length				23 mm diameter, 76 mm length	
Cable	5 m of two conductor, shielded, twisted-pair wire; TPR jacket (high water resistance, high UV stability, flexibility in cold conditions); pigtail lead wires; stainless steel (316), M8 connector located 25 cm from sensor head										
Mass (5 m of cable)	190 g				219 g	190 g				219 g	
Warranty	4 years against defects in materials and workmanship										

Dimensions

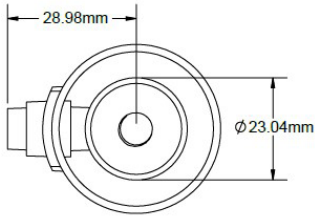

SI-111
22° FOV

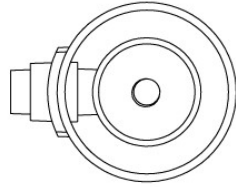

SI-121
18° FOV

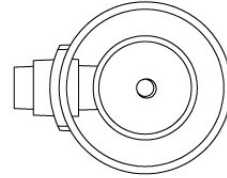

SI-131
14° FOV

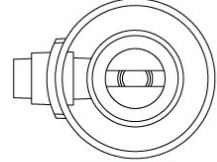

SI-1H1
32° Horizontal FOV
13° Vertical FOV

Research-Grade

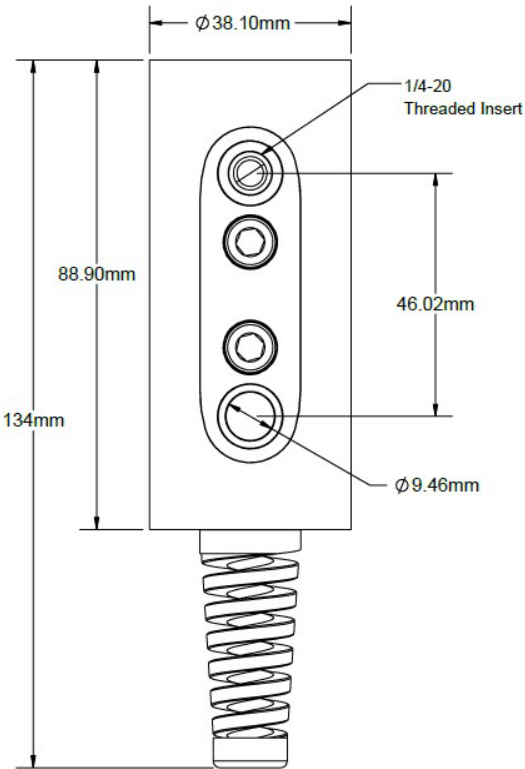

Commercial-Grade

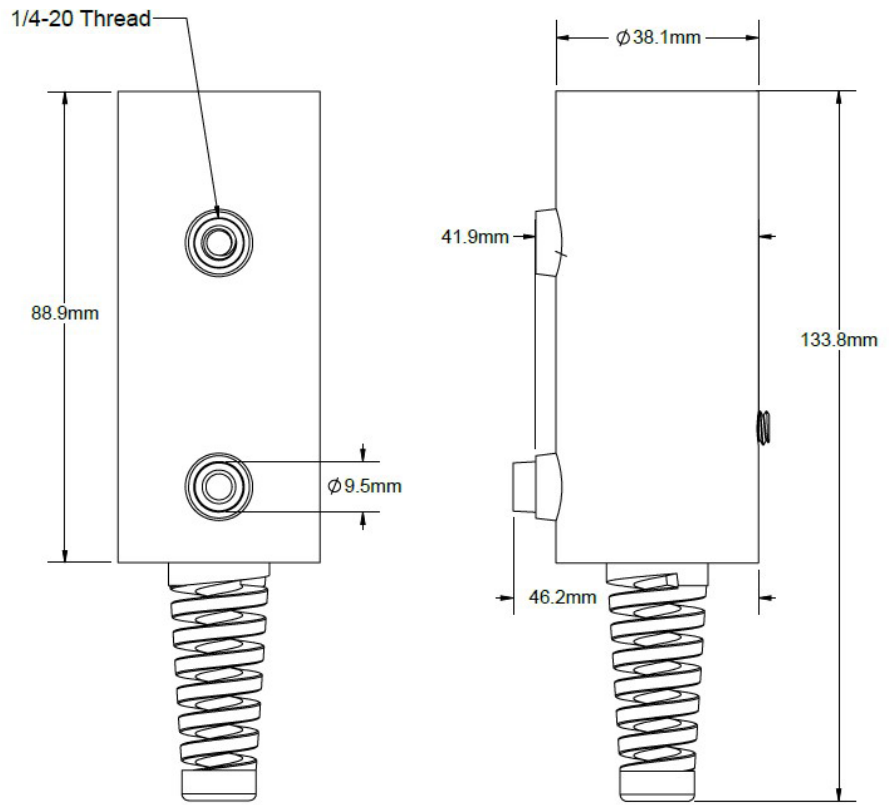

SI-4HR

